

OACIS

Open Architecture Control Integrated System

Timing Sequence

Version 01.56



www.atainc.com

ata@atainc.com

All Rights Reserved

CONTENTS

I.	INITIALIZE OACIS (Turning on the OACIS)	4
II.	REMOTE PROGRAM CALL	5
III.	REMOTE PROGRAM START -> END.....	6
IV.	REMOTE PROGRAM START -> PAUSE or STOP -> RESUME -> END ..	7
V.	REMOTE PROGRAM START -> E STOP -> RESET	8
VI.	REMOTE PROGRAM START -> SOFT STOP -> RESET	9
VII.	REMOTE PROGRAM START -> ERROR -> RESET	10
VIII.	REMOTE HOMING	11
IX.	REMOTE JOG BY DIGITAL INPUT.....	12
X.	READY -> E STOP -> AUTO RESET -> READY	13

 **RETURN HOME BY DI SIGNAL AFTER JOG
MOVING WILL MAKE ERROR HAPPEN
FOR SAFETY REASON.**

Normal sequence,

Home OK & Ready On → Jog Moving by PC command or
PLC → Reset → Return Home by DI signal

I. INITIALIZE OACIS (Turning on the OACIS)

A. Whenever you power on the OACIS, it is to be initialized by itself. While initializing process, it uploads the last used program and configuration. Then it becomes one of below status.

- Error Condition (Ready Off / Error On)

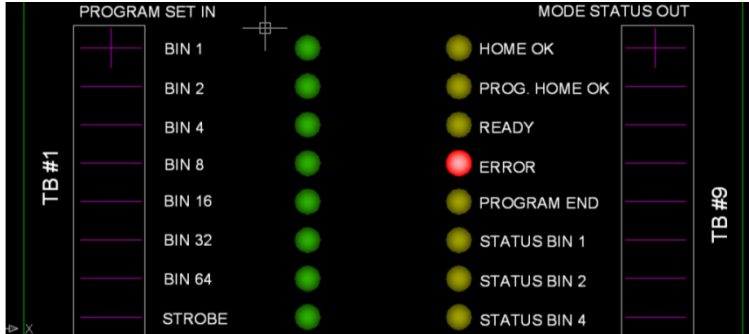

➤ You need to do reset "Error" and Return Home.

- Homing Required #1 Condition (Ready Off / Error Off)

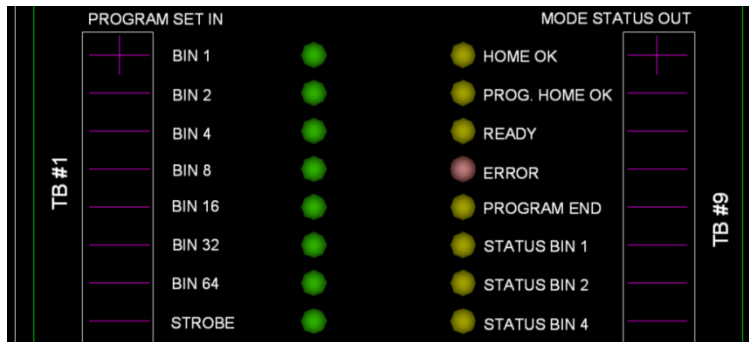

➤ You need to do Return Home.

- If it returned to home position successfully, you can see "Error" Off, "Home Ok" On and "Ready" On.

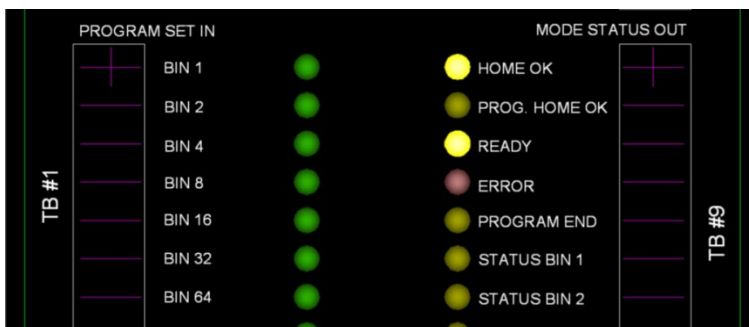

II. REMOTE PROGRAM CALL

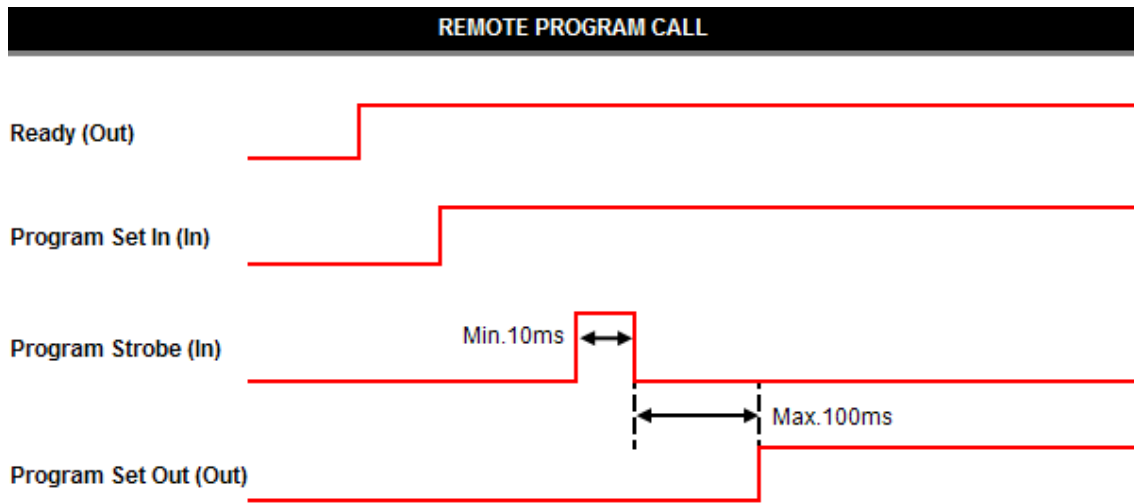

- A. Note #1: Minimum Time Delay is 50ms between Input and Output.
- B. You can also call a specific Program by using the below PC Command.

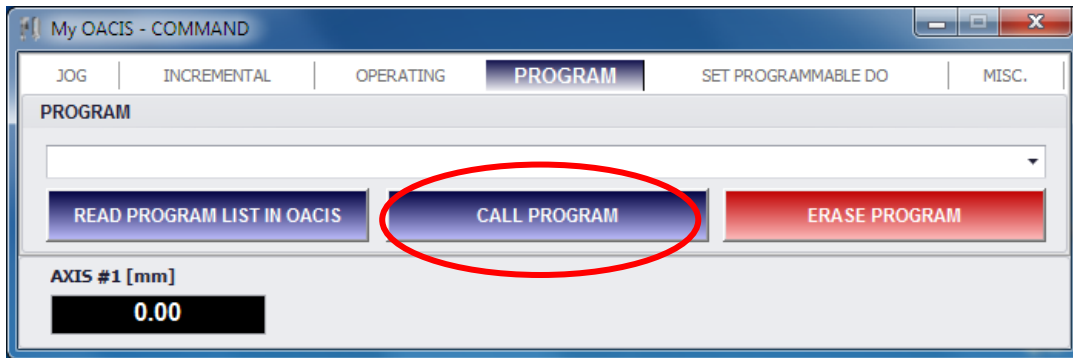

- Read Program List In OACIS -> (Select Program) -> Call Program

TIMING SEQUENCE

III. REMOTE PROGRAM START -> END

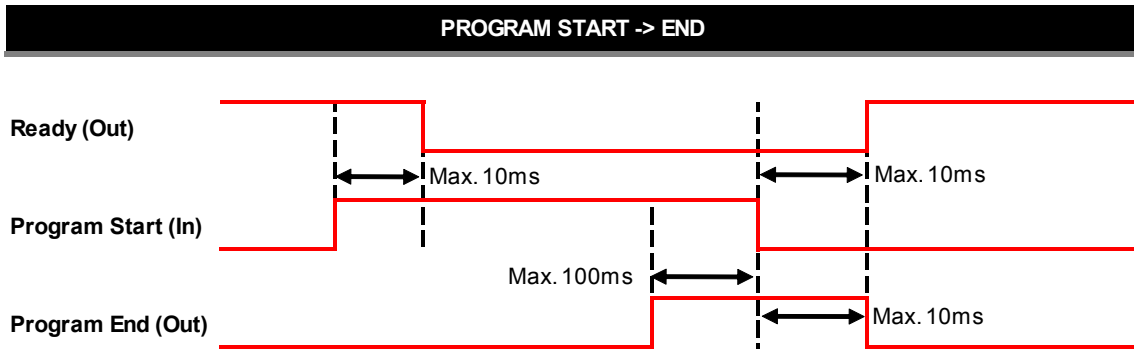

*Axes need to be at Home or Program Home position to turn on Ready Signal on cycle completion.

- A. Note #1: Minimum Time Delay is 50ms between Input and Output.
- B. There are two options to start a program by REMOTE Command like PLC. You can specify the option by setting the user configuration below on the Admin window.

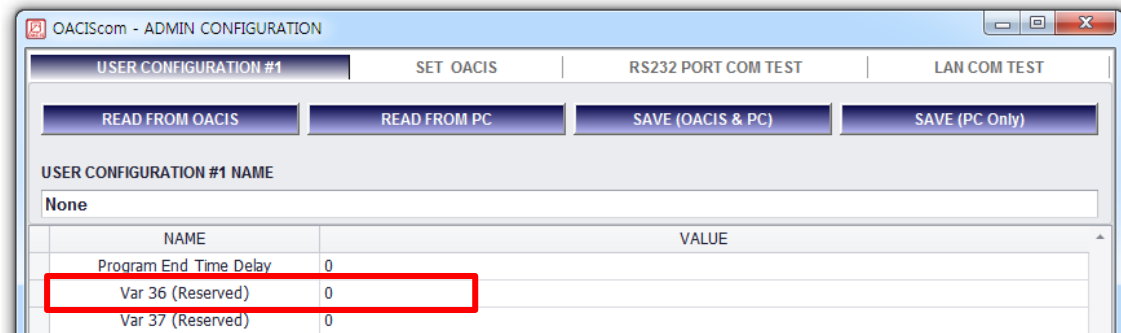

- **0 (Handshake):** Program Start should be kept On until Program End signal becomes turned On. Or an error will occur.
- **1 (Pulse):** A program keeps running until Program End with an only rising edge of Program Start Input Pulse.

C. You can also run a program by using the PC Command below.

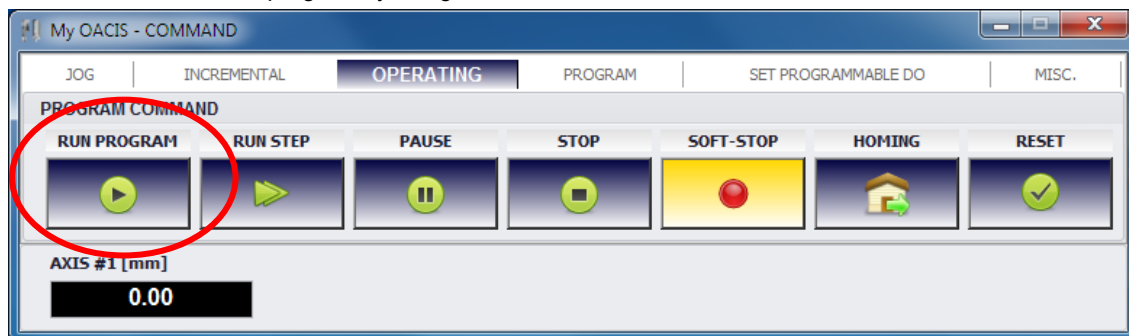

IV. REMOTE PROGRAM START -> PAUSE or STOP -> RESUME -> END

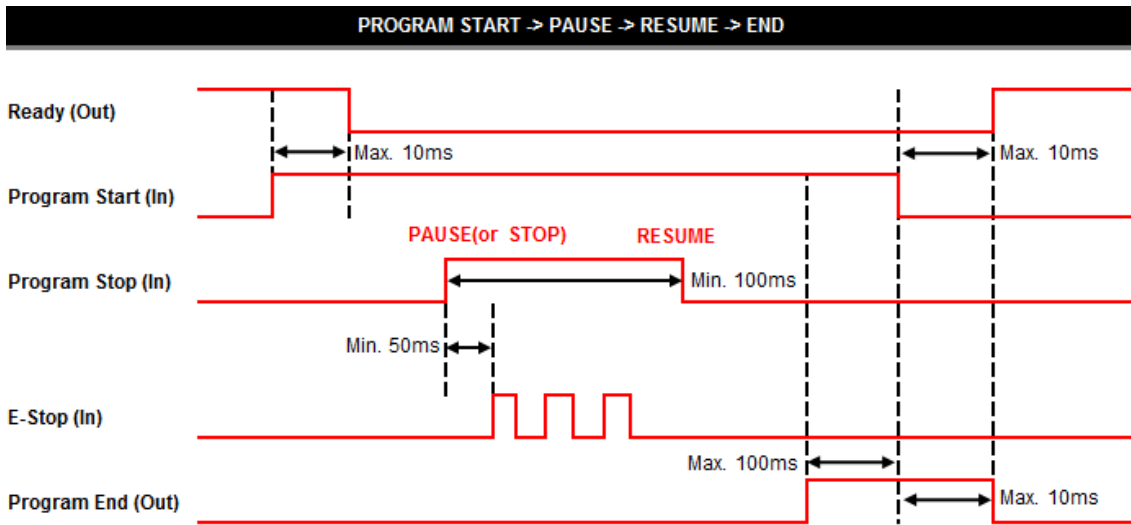

*Axes need to be at Home or Program Home position to turn on Ready Signal on cycle completion.

- A. Note #1: Minimum Time Delay is 50ms between Input and Output.
- B. Note #2: Minimum Time Delay is 100ms between Pause(or Stop) and Resume.
- C. This timing sequence shows how to pause the program before program end. You can use this timing sequence to mute “E-Stop” as well.
- D. There are two options. You can specify the option by setting the user configuration below on the Admin window.

TIMING SEQUENCE

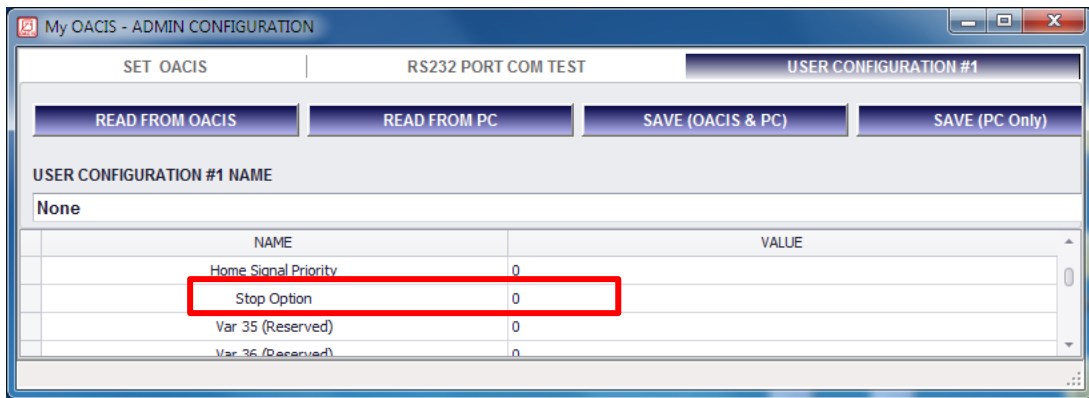

- **0 (Pause):** When you set “Program Stop” as ON at the specific step, OACIS holds the Axis at the position as soon as finishing the step. Then, it moves on to next step by “Program Stop” as Off (Resume).
- **1 (Stop):** OACIS holds the Axis as soon as “Program Stop” On. And it runs the uncompleted step again with “Program Stop” off (Resume).

Note: Even though “E-Stop” signal comes in while “Program Stop” On, OACIS does not fall into error condition. (“E-Stop” is muted by the “Stop” signal).

⚠ CAUTION: Do not use “Program Stop” signal for safety purpose. It may cause severe problems depending on your system.

V. REMOTE PROGRAM START -> E STOP -> RESET

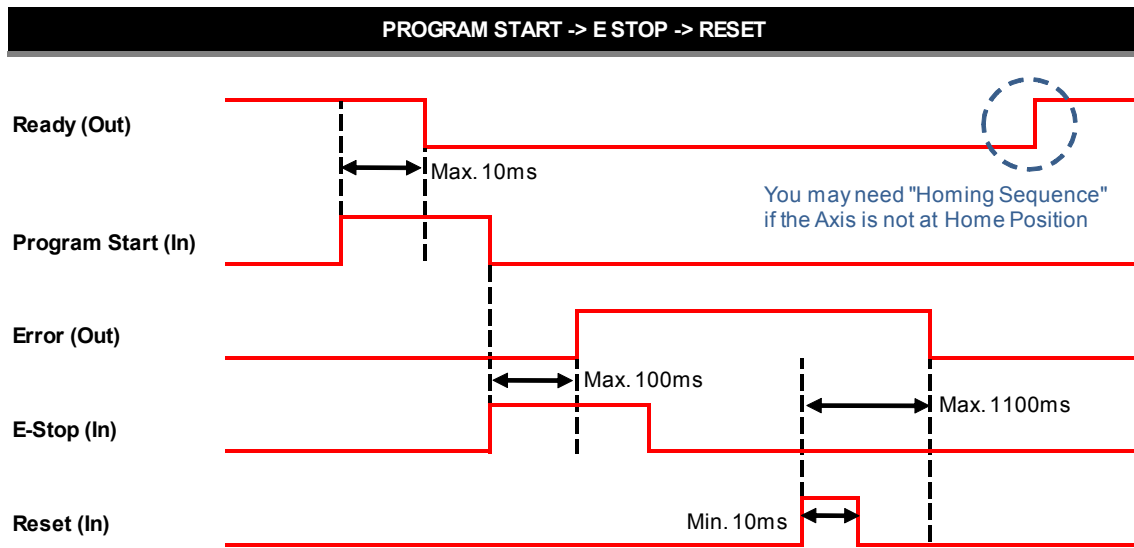

- A. Note #1: Minimum Time Delay is 50ms between Input and Output.
- B. Normally, You need to do "Return Home" after Reset.
- C. If you can't reset "Error" with Reset command, you need to eliminate cause of "Error" first.
- D. You can also reset "Error" by using the below PC Command.

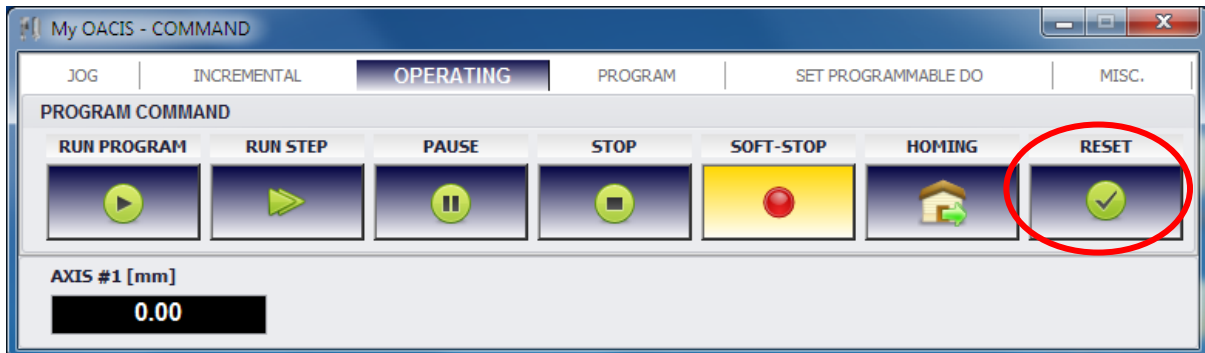

VI. REMOTE PROGRAM START -> SOFT STOP -> RESET

PROGRAM START -> PROGRAM START OFF (Soft Stop) -> ERROR -> RESET

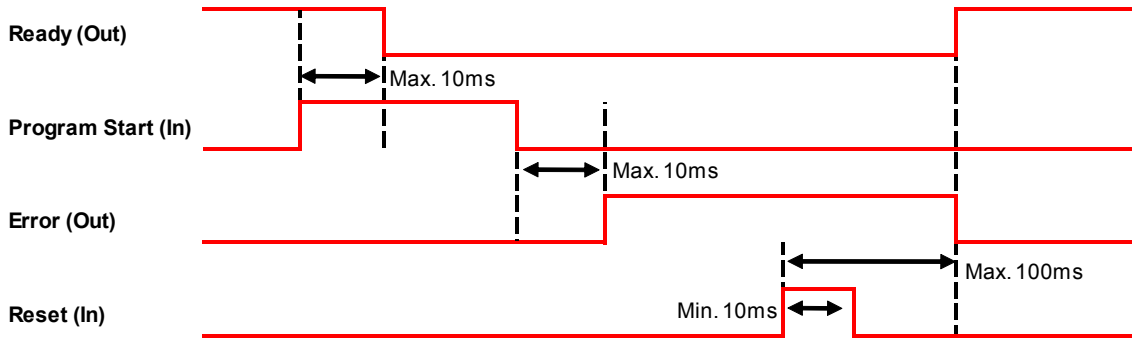

- A. Note #1: Minimum Time Delay is 50ms between Input and Output.
- B. Normally, you need to do "Return Home" after Reset.
- C. If you can't reset "Error" with Reset command, you need to eliminate cause of "Error" first.
- D. You can also reset "Error" by using the below PC Command.
- E. You can also soft-stop by using the below PC Command.

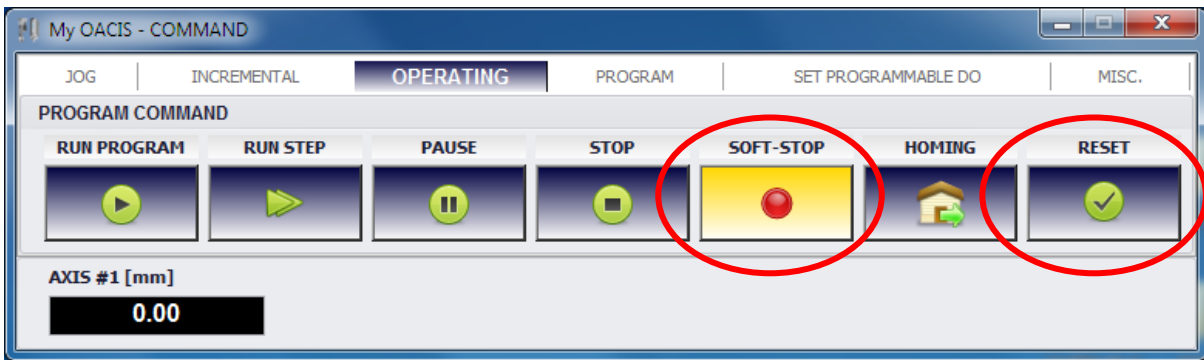

TIMING SEQUENCE

VII. REMOTE PROGRAM START -> ERROR -> RESET

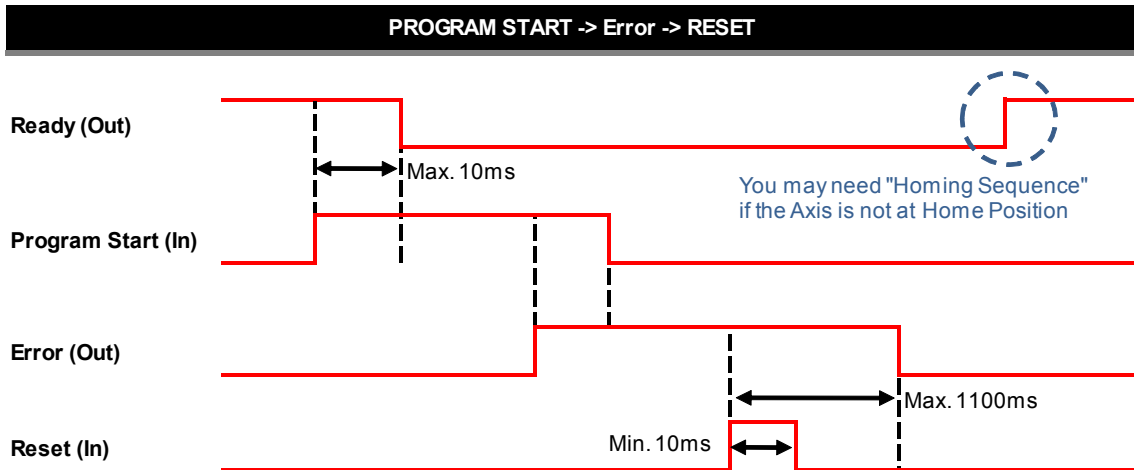

- A. Note #1: Minimum Time Delay is 50ms between Input and Output.
- B. Normally, you need to do "Return Home" after Reset.
- C. If you can't reset "Error" with Reset command, you need to eliminate cause of "Error" first.
- D. You can also reset "Error" by using the below PC Command.

TIMING SEQUENCE

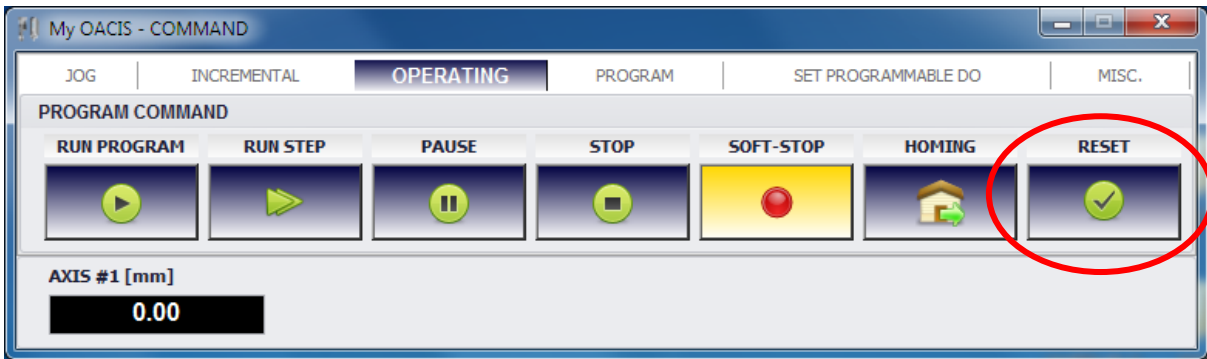

VIII.REMOTE HOMING

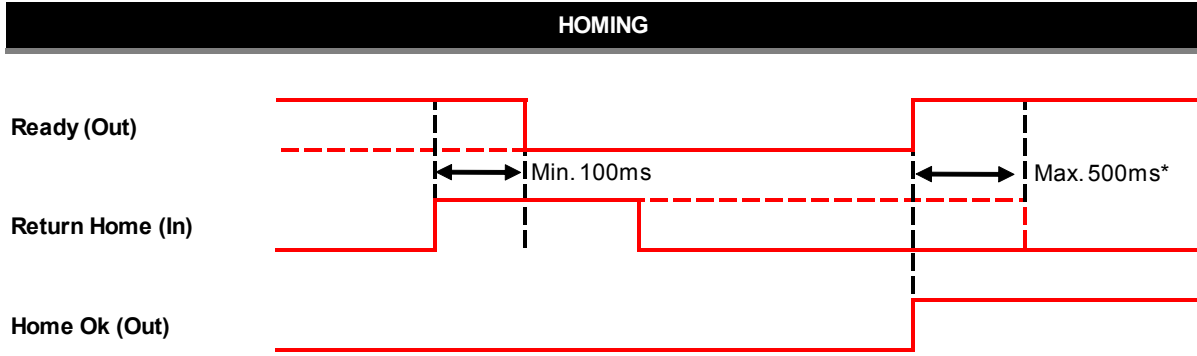

Note*: If this time span is longer than 500ms, OACIS will do Homing Sequence again.

A. You can also do "Homing" by using the below PC Command.

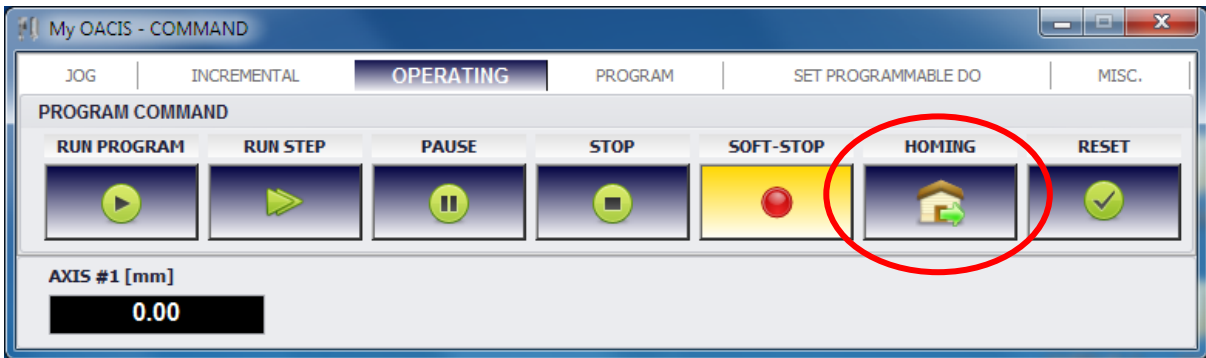

TIMING SEQUENCE

IX. REMOTE JOG BY DIGITAL INPUT

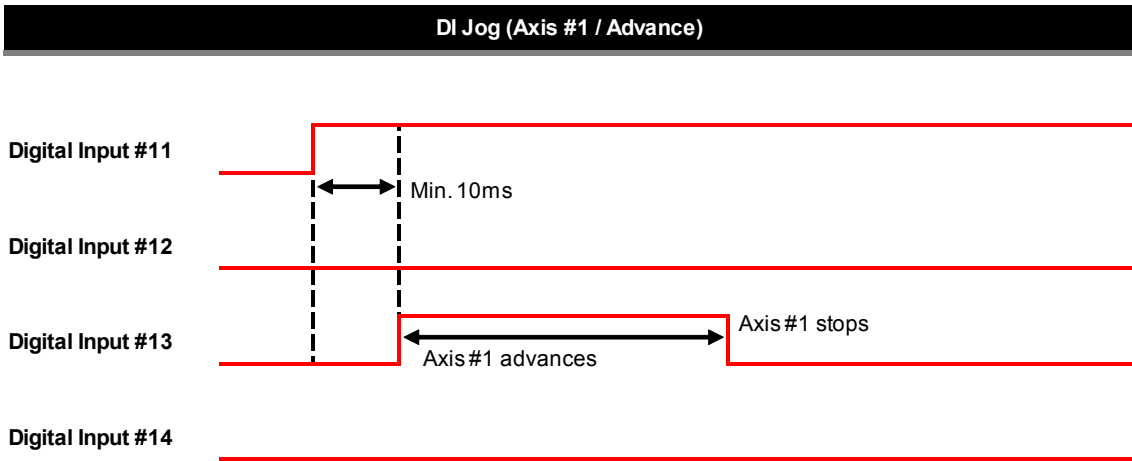

Note:

Axis Selection: DI #11 and #12 (#11: Axis 1 / #12: Axis 2)
 Advance: DI #13
 Retract: DI #14.
 See the manual "How to Configure" for more details.

A. You can also do "Jog" by using the below PC Command.

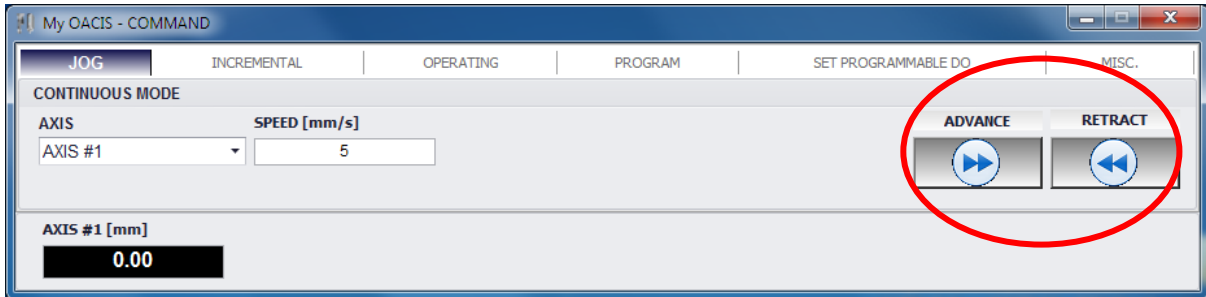

X. READY -> E STOP -> AUTO RESET -> READY

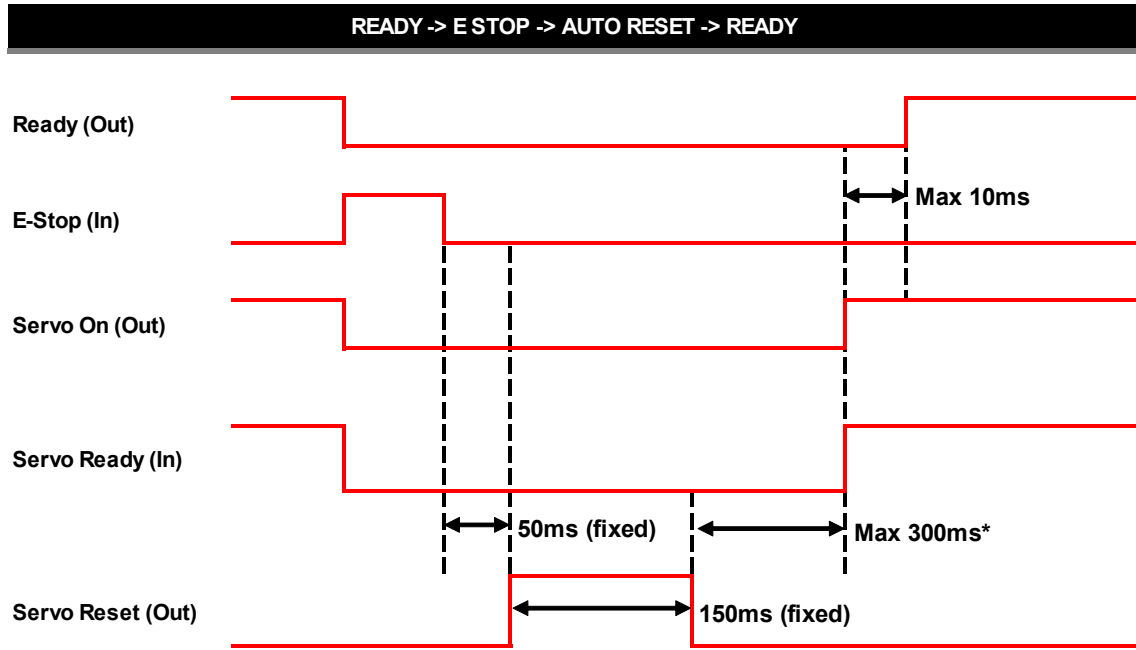

Note*: OACIS sets "Servo Reset" signal on and wait for 300ms until Servo Ready signal gets on. If Servo fails to be Ready, OACIS shows Servo Error.

TIMING SEQUENCE